

INTERFACE CABLE BETWEEN THE TKR-751 AND FLEX IV DSP

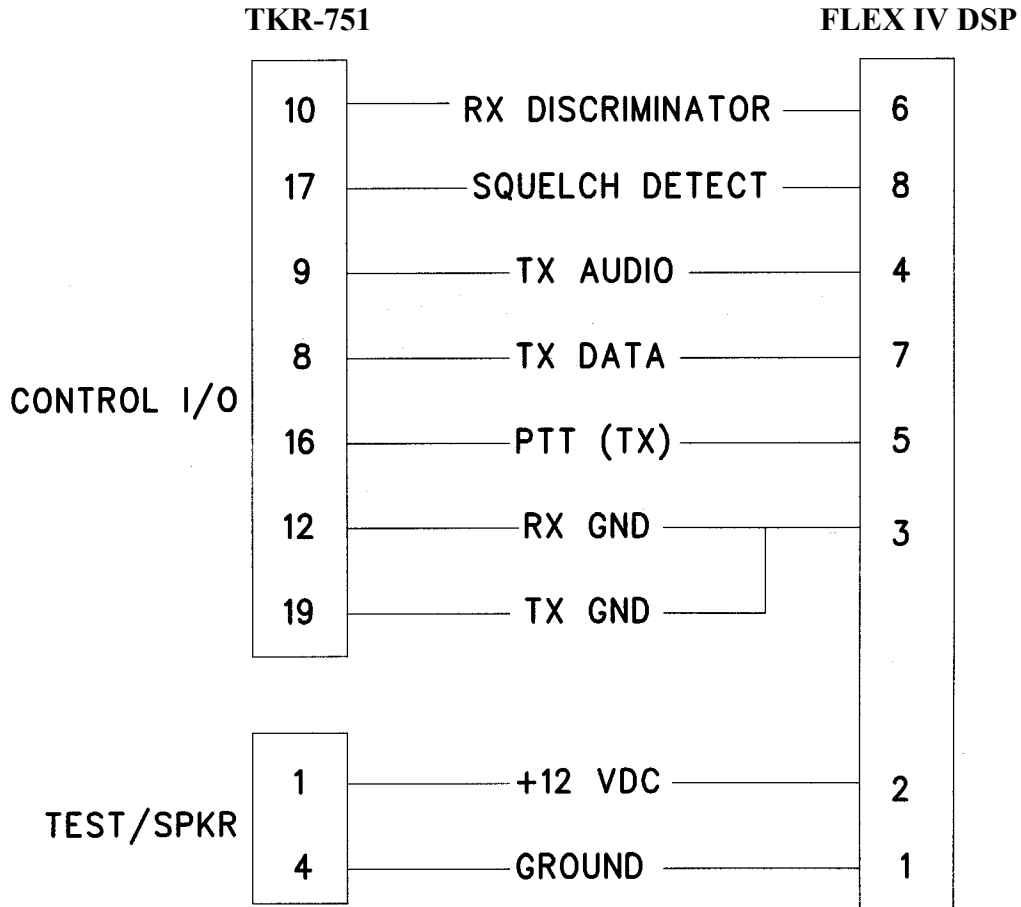

The Kenwood TKR-751 requires a male DB-25 Connector for the CONTROL I/O Jack and a special connector for the TEST/SPKR Jack. The FLEX IV DSP uses a removable screw type of terminal block and requires the bare wire from the DB-25 cable and the TEST SPKR Cable.

Normally Pin 9 and 12 of the TEST/SPKR cable is connected together. This allows the use of the internal speaker.